



Type	Description	For series/item	Unit weight 	Pieces 	ITEM				
					Type	Dim.	Hand	Fin.	Pers. Spec.



- Black nylon rose

02400

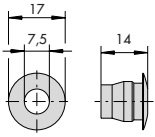
0,001

100

1 06002 00 0

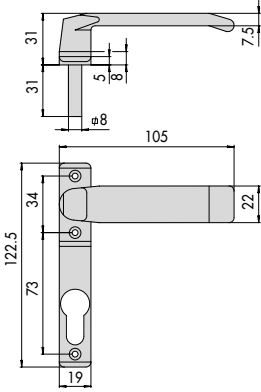

- Black nylon, low handle, charged with 20% glass fibres, specifically for the 46305 series locks
- 3 fastening screws

46305

0,100

12

1 06003 00 0

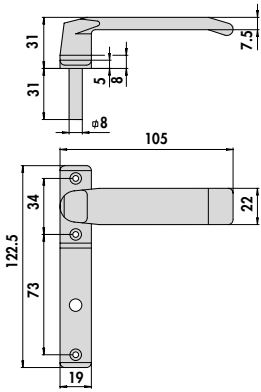

- Handle, in 20 % fiber glass reinforced black nylon, for use with locks series 46305
- 3 fixing screws

0,100

12

1 06003 01 0

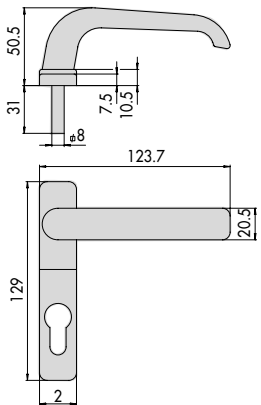

- Black nylon, low handle, charged with 20% glass fibres, specifically for the 46305 series locks
- 3 fastening screws

46305

0,112

12

1 06004 00 0

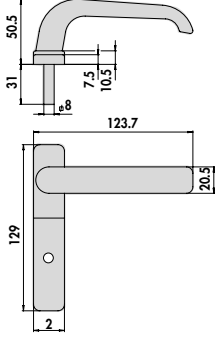
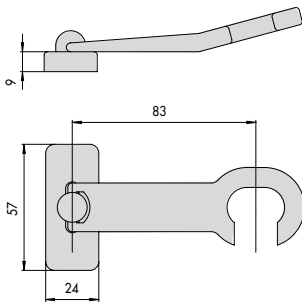
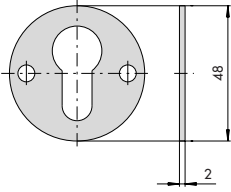
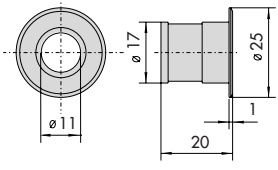
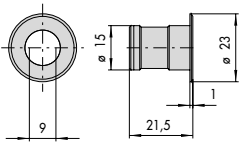
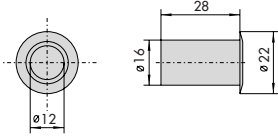
Type	Description	For series/item	Unit weight Kg	Pieces	ITEM				
					Type	Dim.	Hand	Fin.	Pers. Spec.
	<ul style="list-style-type: none"> • Handle and edge cover in 20 % fiber glass reinforced black nylon, for use with locks series 46305 • 3 fixing screws 		0,120	12	1	06004	01	0	
	<ul style="list-style-type: none"> • Lock shutter accessory 		0,100	12	1	06005	00	0	
	<ul style="list-style-type: none"> • Zinc plated steel rose 	42011, 42021, 42031, 42111, 42121, 42211, 42311, 42411, 42421, 42511, 56013, 56016	0,020	100	1	06075	00	0	
	<ul style="list-style-type: none"> • Brass floor striker diameter 11 mm. • FOR: <ul style="list-style-type: none"> - extended bolts with rods diameter 10 mm. 		0,016	12	1	06086	00	0	
	<ul style="list-style-type: none"> • Brass floor striker, diameter 9 mm. • USED FOR: <ul style="list-style-type: none"> - Internal extended bolts with 8 mm. diameter rods 		0,013	12	1	06086	01	0	
	<ul style="list-style-type: none"> • Brass floor striker with spring dust-cover, diameter 12 mm. • USED FOR: <ul style="list-style-type: none"> - Internal extended bolts with 8 mm. diameter rods multi-point locks series 46445 - Extended bolt for Multitop item 1.06449.11.0 		0,020	12	1	06086	02	0	

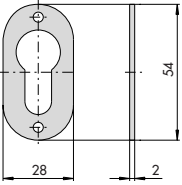
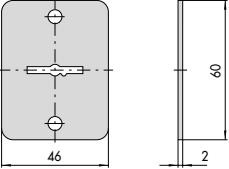
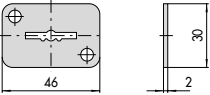
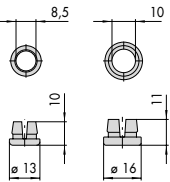
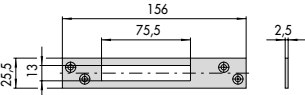
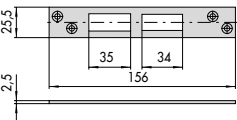
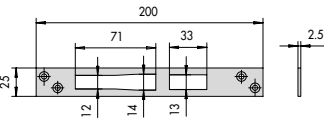

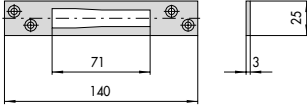
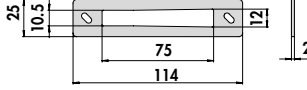
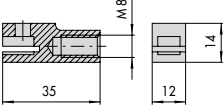
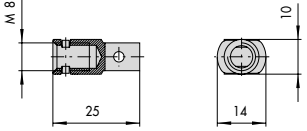
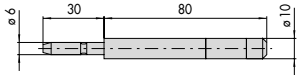
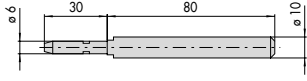
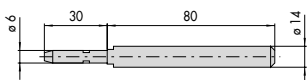
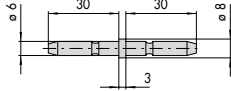
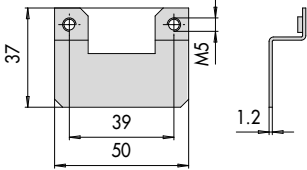
Type	Description	For series/item	Unit weight Kg	Pieces	ITEM			
					Type	Dim.	Hand	Fin.
	• Zinc plated steel rose	42011, 42021, 42031, 42111, 42121, 42211, 42311, 42411, 42421, 42511, 46300, 46310, 46320, 46365, 46375	0,014	100	1	06092	00	0
	• Zinc plated steel rose	17353, 17358, 57013, 57016, 57030, 57035, 57223, 57226, 57313, 57318, 57333, 57336, 57353, 57358, 57378	0,043	12	1	06124	00	0
	• Zinc plated steel rose	17353, 17358, 57013, 57016, 57030, 57035, 57223, 57226, 57313, 57318, 57333, 57336, 57353, 57358, 57378	0,020	12	1	06124	02	0
	• Noise proof bushes for bolts - diameter 8.5 mm. (2 pieces) - diameter 10 mm. (1 piece)	1 06441 00 0, 1 06441 10 0, 1 06441 20 0, 1 06451 00 0, 1 06451 10 0, 1 07088 00 0	0,004	25	1	06147	00	0
	• Zinc plated steel striker	17353, 17358, 56013, 56016, 57013, 57016, 57030, 57035, 57223, 57226, 57333, 57336	0,055	25	1	06232	00	0
	• Zinc plated steel striker	57313, 57318, 57353, 57358, 57378	0,056	25	1	06232	01	0
	• Zinc-plated steel faceplate	46215, 46217, 46225, 46227	0,069	25	1	06232	20	0

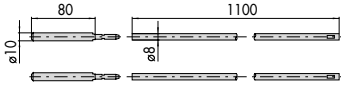
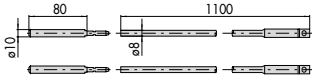
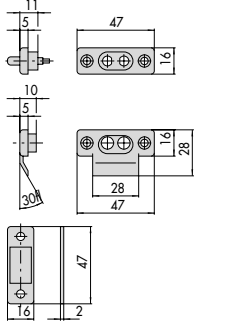
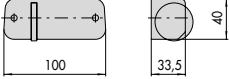
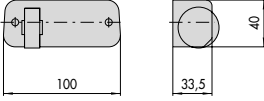
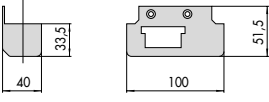
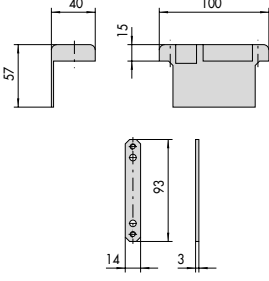
Type	Description	For series/item	Unit weight Kg	Pieces	ITEM				
					Type	Dim.	Hand	Fin.	Pers.
	<ul style="list-style-type: none"> Zinc plated steel striker 	46300, 46302, 46305, 46310, 46312, 46320, 46322, 46365	0,056	25	1	06232	21	0	
	<ul style="list-style-type: none"> Adjustable zinc-plated steel striker 2 fastening screws 	46305	0,050	25	1	06232	22	0	
	<ul style="list-style-type: none"> Set of threaded bushes (M8) in metal 	1 06441 20 0, 17358, 46320, 46322, 57358, 57378	0,050	12	1	06290	05	0	
	<ul style="list-style-type: none"> Pair of threaded steel bushings (M8), anti-unscrewing 	46300, 46302, 46365, 46375, 56016, 57016, 57035, 57226, 57318, 57336	0,025	25	1	06290	10	0	
	<ul style="list-style-type: none"> Zinc plated steel saw resistant tip, 10 mm. Side push resistance KN 15 	1 06415 00 0, 1 06416 00 0, 1 06441 15 0	0,056	12	1	06291	00	0	
	<ul style="list-style-type: none"> Zinc plated hardened steel tip, dia. 10 mm. Side push resistance KN 25 	1 06415 00 0, 1 06416 00 0, 1 06441 15 0, 1 07088 03 0	0,054	12	1	06291	05	0	
	<ul style="list-style-type: none"> Zinc plated hardened steel tip, dia. 14 mm 	1 07088 05 0	0,038	12	1	06291	07	0	
	<ul style="list-style-type: none"> Zinc plated steel pin connector 	1 06415 00 0, 1 06416 00 0, 1 06441 00 0, 1 06441 10 0, 1 06441 15 0, 1 06441 20 0, 1 06451 00 0, 1 06451 10 0, 1 07088 00 0, 1 07088 03 0	0,016	12	1	06291	20	0	
	<ul style="list-style-type: none"> Plate complete with 2 M5 fixing screws for rolling shutters series 41510, 41525, 41526 	41510, 41525, 41526	0,014	50	1	06316	00	0	

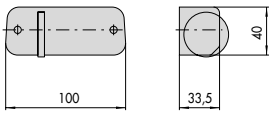
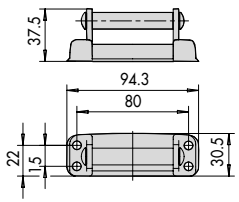
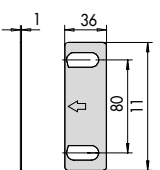
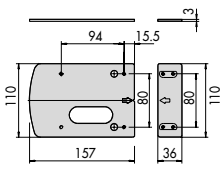
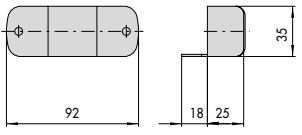
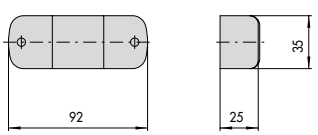
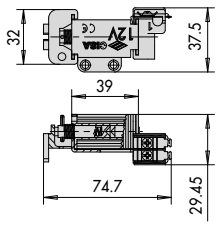
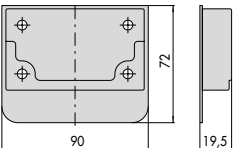
Type	Description	For series/item	Unit weight	Pieces	ITEM			
					Type	Dim.	Hand	Fin.
	<ul style="list-style-type: none"> • Zinc plated extended bolts SUPPLIED AS STANDARD: • Pair of bolts dia. 8 mm. • Pair of tips dia. 10 mm. item 1.06291.05.0 	52526, 56016, 56255, 57015, 57016, 57019, 57033, 57035, 57055, 57215, 57217, 57225, 57226, 57255, 57256, 57259, 57265, 57296, 57318, 57336	0,533	12	1	06415	00	0
	<ul style="list-style-type: none"> • Zinc plated extended bolts • SUPPLIED AS STANDARD: - Pair of bolts diameter 8 mm. - Pair of tips diameter 10 mm. item 1.06291.05.0 	17358, 46320, 46322, 57358, 57378	0,530	12	1	06441	15	0
	<ul style="list-style-type: none"> • Nylon contact set complete with spacers: 2 mm. (Pcs. 4) 	11000, 12000, 13000	0,035	6	1	06510	00	0
	<ul style="list-style-type: none"> • Zinc plated roller striker 	11521, 11551	0,208	6	1	07016	00	1
			0,208	6	1	07016	00	2
	<ul style="list-style-type: none"> • Zinc plated roller striker 	11721, 11726, 11731, 11736, 11921, 11931	0,183	6	1	07018	00	1
			0,182	6	1	07018	00	2
	<ul style="list-style-type: none"> • Zinc plated striker 	11921, 11931	0,172	6	1	07018	00	3
			0,183	6	1	07018	00	4
	<ul style="list-style-type: none"> • Striker set including: - slide - anchoring plate - screws 	11610, 11921, 11931	0,100	1	1	07018	10	3
			0,100	1	1	07018	10	4

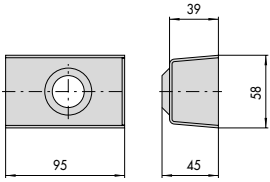
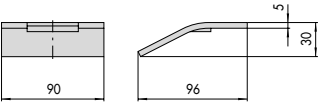
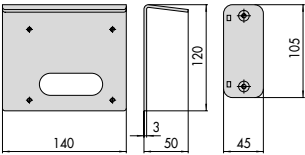
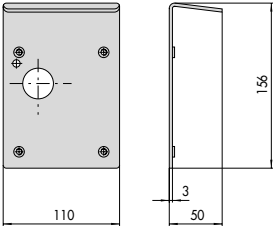
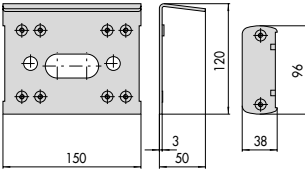
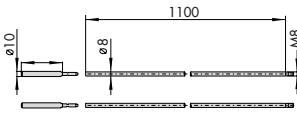
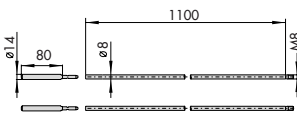
Type	Description	For series/item	Unit weight Kg	Pieces	ITEM				
					Type	Dim.	Hand	Fin.	Pers. Spec.
	• Zinc plated roller striker	11761, 11771	0,198	6	1	07020	00	1	
			0,198	6	1	07020	00	2	
	• Striker	1A721, 1A731	0,200	6	1	07021	00	0	
	• 1 mm spacer for striker	1A721, 1A731	0,025	6	1	07021	01	0	
	• Backplate for lock and striker to be welded	1A721, 1A731	0,435	6	1	07021	05	0	
	• Zinc plated striker	50411, 50421, 50461, 50471, 50481	0,092	6	1	07024	01	1	
			0,092	6	1	07024	01	2	
	• Zinc plated striker	50511, 50521, 50561, 50571, 50581	0,080	6	1	07024	02	1	
			0,094	6	1	07024	02	2	
	• Coil set • 12V ac CE	1A610, 1A611, 1A630, 1A631, 1A721, 1A731	0,092	6	1	07025	00	0	
	• Zinc plated striker	55254, 55264, 55274, 55284	0,137	6	1	07037	01	0	

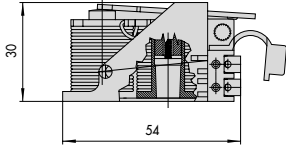
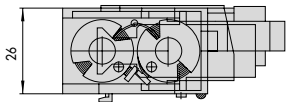
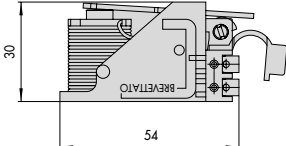
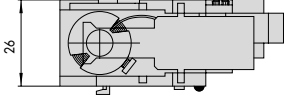
Type	Description	For series/item	Unit weight Kg	Pieces	ITEM				
					Type	Dim.	Hand	Fin.	Pers. Spec.
	• Zinc plated steel protective box for outside cylinder		0,200	10	1	07056	00	0	
	• Zinc plated steel floor striker	11823	0,307	12	1	07058	00	0	
	• Protective back plate, striker spacer and zinc plated steel screws	11721, 11726, 11731, 11736, 11761, 11771, 11921, 11931	0,645	20	1	07061	00	1	
	• Protective back plate with zinc plated steel screws	11823	0,525	20	1	07061	01	1	
	• Protective back plate, striker spacer and zinc plated steel screws	50411, 50421, 50471, 50481, 50511, 50521, 50571, 50581	0,635	20	1	07061	10	0	
	• Zinc plated extended bolts • SUPPLIED AS STANDARD: - Pair of bolts diameter 8 mm. - Pair of tips diameter 10 mm. item 1.06291.05.0	17358, 46300, 46302, 46305, 46320, 46322, 46365, 46375, 56016, 57016, 57035, 57226, 57318, 57336, 57358, 57378	0,600	12	1	07088	03	0	
	• Zinc plated extended bolts • SUPPLIED AS STANDARD: - Pair of bolts diameter 8 mm. - Pair of tips diameter 14 mm. item 1.06291.07.0	17358, 46300, 46302, 46305, 46320, 46322, 46365, 46375, 56016, 57016, 57035, 57226, 57318, 57336, 57358, 57378	0,575	12	1	07088	05	0	

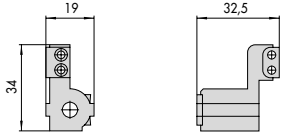
Type	Description	For series/item	Unit weight Kg	Pieces	ITEM				
					Type	Dim.	Hand	Fin.	Pers. Spec.
 	<ul style="list-style-type: none"> • Coil set • 12 V ac • Black nylon support 	11521, 11540,	0,092	6	1	07118	00	1	
		11551, 11560, 11610, 11611, 11630, 11631, 11660, 11661, 11670, 11671, 11721, 11731, 11761, 11771, 11823, 11921, 11931	0,092	6	1	07118	00	2	
 	<ul style="list-style-type: none"> • Adjustable coil set • 12 V ac • Blue nylon support 	11521, 11540,	0,075	6	1	07120	00	1	
		11551, 11560, 11610, 11611, 11630, 11631, 11660, 11661, 11670, 11671, 11721, 11731, 11761, 11771, 11823, 11921, 11931	0,074	6	1	07120	00	2	
 	<ul style="list-style-type: none"> • Adjustable coil set • 24 V ac • Blue nylon support 	11540, 11560,	0,075	6	1	07120	01	1	
		11610, 11611, 11630, 11631, 11660, 11661, 11670, 11671	0,082	6	1	07118	01	2	
	<ul style="list-style-type: none"> • Set of coils • 12 V ac CE 	17352, 17353, 17357, 17358	0,035	6	1	07128	00	0	
		17352, 17353, 17357, 17358	0,035	6	1	07128	01	0	