







Type	Description	For series/item	Unit weight 	Pieces 	ITEM				
					Type	Dim.	Hand	Fin.	Peris. Spec.
	<ul style="list-style-type: none"> <li>• Outside brass escutcheon</li> </ul>	57110, 57115, 57120, 57125, 57130, 57135, 57150, 57155, 57160, 57165, 57170, 57175	0,029	12	1	06140	00	0	
	<ul style="list-style-type: none"> <li>• Hollow outside brass escutcheon</li> <li>• A = 10, door thickness 60 mm.</li> </ul>	57110, 57115, 57120, 57125, 57130, 57135, 57150, 57155, 57160, 57165, 57170, 57175	0,032	12	1	06140	01	0	
	<ul style="list-style-type: none"> <li>• Hollow outside brass escutcheon</li> <li>• A = 22, door thickness 70 mm.</li> </ul>	57110, 57115, 57120, 57125, 57130, 57135, 57150, 57155, 57160, 57165, 57170, 57175	0,037	12	1	06140	02	0	
	<ul style="list-style-type: none"> <li>• Bronze lacquered steel top striker</li> </ul>	57120, 57125, 57130, 57135, 57160, 57165, 57170, 57175, 57190	0,100	12	1	06236	00	0	
	<ul style="list-style-type: none"> <li>• Brass floor striker</li> </ul>	57120, 57125, 57130, 57135, 57160, 57165, 57170, 57175, 57190	0,025	12	1	06237	00	0	
	<ul style="list-style-type: none"> <li>• Brass floor striker with sprung dust cover</li> </ul>	57120, 57125, 57130, 57135, 57160, 57165, 57170, 57175, 57190	0,028	12	1	06237	01	0	
	<ul style="list-style-type: none"> <li>• Bronze lacquered steel adjustable extended bolt</li> </ul>	57120, 57125, 57130, 57135, 57160, 57165, 57170, 57175, 57190	0,734	6	1	06417	00	0	

Type	Description	For series/item	Unit weight Kg	Pieces	ITEM				
					Type	Dim.	Hand	Fin.	Pers.
	<ul style="list-style-type: none"> <li>• Set of bronze lacquered steel diverting devices</li> </ul>	57120, 57125, 57130, 57135, 57160, 57165, 57170, 57175	0,050	12	1	06418	00	0	
	<ul style="list-style-type: none"> <li>• Bronze lacquered steel adjustable connecting rod</li> </ul>	57130, 57135, 57170, 57175	0,412	4	1	06419	00	0	
	<ul style="list-style-type: none"> <li>• Bronze lacquered steel bar guide</li> </ul>	57120, 57125, 57130, 57135, 57160, 57165, 57170, 57175, 57190	0,030	24	1	06422	00	0	
	<ul style="list-style-type: none"> <li>• Bronze lacquered steel cranked adjustable extended bolt</li> </ul>	57120, 57125, 57130, 57135, 57160, 57165, 57170, 57175	0,770	1	1	06423	00	0	
	<ul style="list-style-type: none"> <li>• Bronze lacquered steel long adjustable extended bolt</li> </ul>	57120, 57125, 57130, 57135, 57160, 57165, 57170, 57175, 57190	0,766	6	1	06424	00	0	
	<ul style="list-style-type: none"> <li>• Set of extended bolts including one item 06417 and one item 06424</li> </ul>	57120, 57125, 57160, 57165, 57190	1,500	1	1	06425	00	0	
	<ul style="list-style-type: none"> <li>• Set of extended bolts including two items 06417</li> </ul>	57120, 57125, 57160, 57165, 57190	1,480	1	1	06425	01	0	

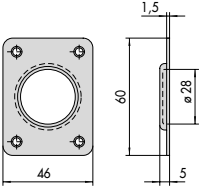
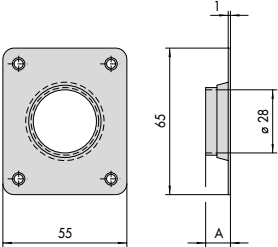
Type	Description	For series/item	Unit weight 	Pieces 	ITEM			
					Type	Dim.	Hand	Fin.

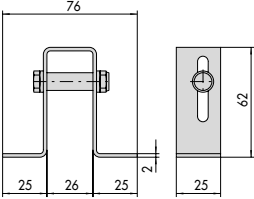
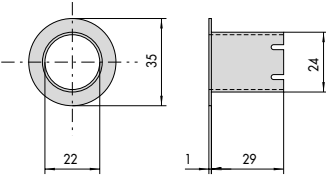
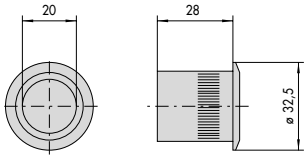
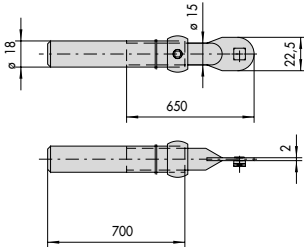
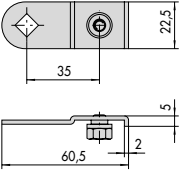
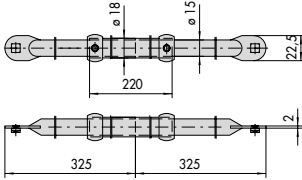
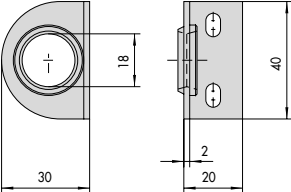
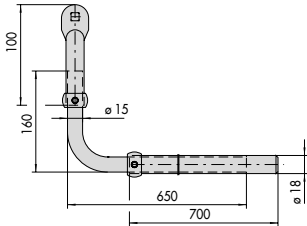
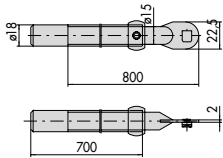
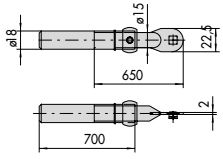
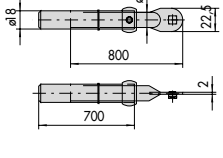

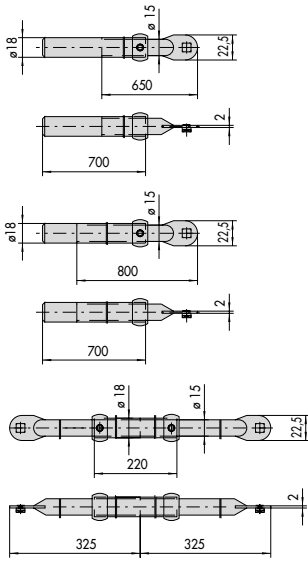
- Set of extended bolts including two items 06417, one item 06424 and one item 06419

57130, 57135, 3,200 1 1 06426 00 0  
57170, 57175

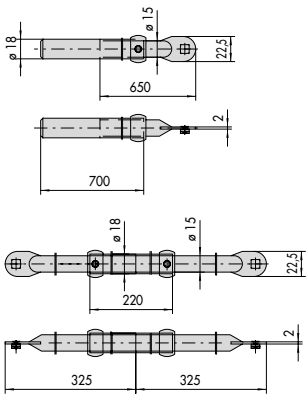

- Set of extended bolts including four items 06417 and one item 06419

57130, 57135, 3,280 1 1 06426 01 0  
57170, 57175

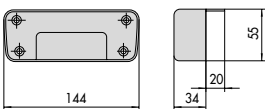

- Bronze lacquered steel striker

57110, 57115, 0,320 2 1 07054 00 0  
57120, 57125,  
57130, 57135,  
57150, 57155,  
57160, 57165,  
57170, 57175

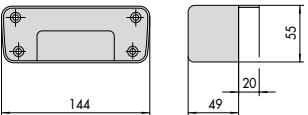

- Bronze lacquered steel top striker

57110, 57115, 0,442 2 1 07055 00 0  
57120, 57125,  
57130, 57135,  
57150, 57155,  
57160, 57165,  
57170, 57175