



*New Cambio Facile System
double-bitted key rekeyable locks*



New Cambio Facile System double-bitted key rekeyable locks

OPERATION

- If keys are lost, or whenever keys must be temporarily left with other people you are unsure you can trust, the lock key bitting can be changed at any time.
- The keys can be changed easily, without having to disassemble the lock or parts of it, and for an unlimited number of times.

SECURITY

- The double-bit key operates the 6 anti-friction levers arranged in 2 sets, separated by the deadbolt tang, each lever being activated by an independent helical spring.
- Coupled with special manganese steel guard assembly plates (item 1.06429.50.0) the New Cambio Facile System is rated a top security product by the European Standard UNI EN 12209:03.

AVAILABLE MODELS

With and without latch-bolt, with electrically operated latch-bolt, with front locking or three locking points.

- Double lock version (Multifunction New Cambio Facile/cylinder): 2 locks, coupled to obtain a single product performing different functions for enhanced handiness and security.

RANGE

Developed according to 2 dimensional standards to meet any installation requirements.

CERTIFICATES

All New Cambio Facile locks have been designed and tested to meet the strictest requirements provided for by the Draft European Standard UNI EN 12209:03.

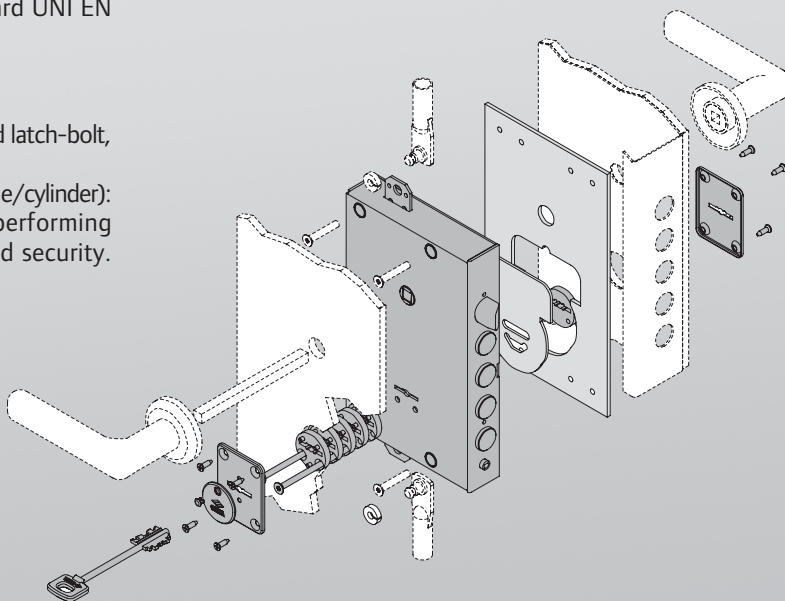

**Technical features:**

- Steel case and cover.
- Nickel-plated steel faceplate (mortice locks).
- Nickel-plated steel deadbolts, 4 throws.
- Non-handed nickel-plated latch-bolt.
- Anti-picking latch-bolt (electrically operated locks).
- Nickel-plated reloading pin (electrically operated locks).
- Coil set with built-in terminal block, 12 V, 15 W ac (electrically operated locks).
- Anti-crush plates for screw fixing.
- Steel active pins.
- Packaging: 1 or 5 pieces (industrial packs).

Operation:

- From the inside: the latch-bolt can be remotely controlled (electrically controlled locks) or key- or handle-operated; the dead-bolts are key-operated.
- From the outside: the latch-bolt and dead-bolts are operated with the key.
- VERSION WITH CONSTRUCTION KEY:
 - The key operates the first four throws.

Finishes:

- Zinc plated aluminium.

R./L. Hand Opening:

0 = non-handed.









Standard equipment:

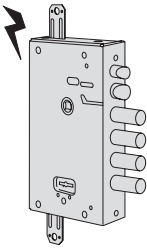



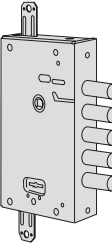

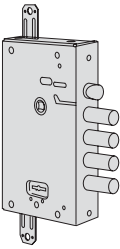

- Keys.
- Instruction sheet.
- Inside escutcheon item 1.06143.00.0, outside escutcheon item 1.06082.00.0, key guide item 1.06142.01.0 (rim locks).
- Inside escutcheon item 1.06143.00.0, item 1.06082.00.0 (mortice locks).

On request:

- Roses series 06144, 06145.
- Mounting plates series 06429.

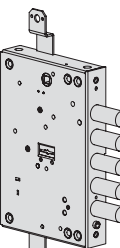

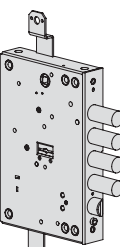
Type	Description	Item key	Dead-bolts								ITEM							
			No.	Projection	Distance	Throws	Distance	Faceplate	Backset	Unit weight Kg	Pieces	Type	Dim.	Hand	Fin.	Pers.	Spec.	
 <ul style="list-style-type: none"> • Latch-bolt and dead-bolt • Electrically controlled dead-locking latch-bolt • Voltage: 12 V ac CE • Slide item 1.06224.50.0 	 3 item 1 00163 00 1	4	3,5	25	4	85	-	64	2,650	1	1 17615 25 A							
		4	3,5	27	4	85	-	64	2,650	1	1 17615 27 A							
		4	3,5	28	4	85	-	64	2,650	1	1 17615 28 A							
		3	3,5	32	4	85	-	64	2,650	1	1 17615 32 A							
		3	3,5	38	4	85	-	64	2,650	1	1 17615 38 A							
		4	3,5	25	4	85	-	64	2,350	5	1 17615 45 A							
		4	3,5	27	4	85	-	64	2,350	5	1 17615 47 A							
		4	3,5	28	4	85	-	64	2,350	5	1 17615 48 A							
		3	3,5	32	4	85	-	64	2,350	5	1 17615 52 A							
		3	3,5	38	4	85	-	64	2,350	5	1 17615 58 A							
		<ul style="list-style-type: none"> • VERSION WITH CONSTRUCTION KEY • Latch-bolt and dead-bolt • Electrically controlled dead-locking latch-bolt • Voltage: 12 V ac CE • Slide item 1.06224.50.0 	 3 item 1 00163 00 1  1 item 1 00120 00 1 (construction key)	4	3,5	25	4	85	-	64	2,750	1	1 17665 25 A					
				4	3,5	27	4	85	-	64	2,750	1	1 17665 27 A					
				4	3,5	28	4	85	-	64	2,750	1	1 17665 28 A					
				3	3,5	32	4	85	-	64	2,750	1	1 17665 32 A					
3	3,5			38	4	85	-	64	2,750	1	1 17665 38 A							
4	3,5			25	4	85	-	64	2,450	5	1 17665 45 A							
4	3,5			27	4	85	-	64	2,450	5	1 17665 47 A							
4	3,5			28	4	85	-	64	2,450	5	1 17665 48 A							
3	3,5			32	4	85	-	64	2,450	5	1 17665 52 A							
3	3,5			38	4	85	-	64	2,450	5	1 17665 58 A							
 <ul style="list-style-type: none"> • Dead-bolt only 	 3 item 1 00163 00 1			5	3,5	25	4	85	-	64	2,450	1	1 57605 25 A					
				5	3,5	27	4	85	-	64	2,450	1	1 57605 27 A					
				5	3,5	28	4	85	-	64	2,450	1	1 57605 28 A					
				4	3,5	32	4	85	-	64	2,450	1	1 57605 32 A					
		4	3,5	38	4	85	-	64	2,450	1	1 57605 38 A							
		5	3,5	25	4	85	-	64	2,150	5	1 57605 45 A							
		5	3,5	27	4	85	-	64	2,150	5	1 57605 47 A							
		5	3,5	28	4	85	-	64	2,150	5	1 57605 48 A							
		4	3,5	32	4	85	-	64	2,150	5	1 57605 52 A							
		4	3,5	38	4	85	-	64	2,150	5	1 57605 58 A							
		<ul style="list-style-type: none"> • VERSION WITH CONSTRUCTION KEY • Dead-bolt only 	 3 item 1 00163 00 1  1 item 1 00120 00 1 (construction key)	5	3,5	25	4	85	-	64	2,550	1	1 57655 25 A					
				5	3,5	27	4	85	-	64	2,550	1	1 57655 27 A					
				5	3,5	28	4	85	-	64	2,550	1	1 57655 28 A					
				4	3,5	32	4	85	-	64	2,550	1	1 57655 32 A					
4	3,5			38	4	85	-	64	2,550	1	1 57655 38 A							
5	3,5			25	4	85	-	64	2,250	5	1 57655 45 A							
5	3,5			27	4	85	-	64	2,250	5	1 57655 47 A							
5	3,5			28	4	85	-	64	2,250	5	1 57655 48 A							
4	3,5			32	4	85	-	64	2,250	5	1 57655 52 A							
4	3,5			38	4	85	-	64	2,250	5	1 57655 58 A							

Type	Description	Item key	Dead-bolts								ITEM						
			No.	Projection	Distance	Throws	Distance	Faceplate	Backset	Unit weight Kg	Pieces	Type	Dim.	Hand	Fin.	Pers.	Spec.
	<ul style="list-style-type: none"> Latch-bolt and dead-bolt 	 3 item 1 00163 00 1	4	3,5	25	4	85	-	64	2,600	1	1 57615 25 A					
			4	3,5	27	4	85	-	64	2,600	1	1 57615 27 A					
			4	3,5	28	4	85	-	64	2,600	1	1 57615 28 A					
			3	3,5	32	4	85	-	64	2,600	1	1 57615 32 A					
			3	3,5	38	4	85	-	64	2,600	1	1 57615 38 A					
			4	3,5	25	4	85	-	64	2,300	5	1 57615 45 A					
			4	3,5	27	4	85	-	64	2,300	5	1 57615 47 A					
			4	3,5	28	4	85	-	64	2,300	5	1 57615 48 A					
			3	3,5	32	4	85	-	64	2,300	5	1 57615 52 A					
			3	3,5	38	4	85	-	64	2,300	5	1 57615 58 A					
	<ul style="list-style-type: none"> VERSION WITH CONSTRUCTION KEY Latch-bolt and dead-bolt 	 3 item 1 00163 00 1  1 item 1 00120 00 1 (construction key)	4	3,5	25	4	85	-	64	2,700	1	1 57665 25 A					
			4	3,5	27	4	85	-	64	2,700	1	1 57665 27 A					
			4	3,5	28	4	85	-	64	2,700	1	1 57665 28 A					
			3	3,5	32	4	85	-	64	2,700	1	1 57665 32 A					
			3	3,5	38	4	85	-	64	2,700	1	1 57665 38 A					
			4	3,5	25	4	85	-	64	2,400	5	1 57665 45 A					
			4	3,5	27	4	85	-	64	2,400	5	1 57665 47 A					
			4	3,5	28	4	85	-	64	2,400	5	1 57665 48 A					
			3	3,5	32	4	85	-	64	2,400	5	1 57665 52 A					
			3	3,5	38	4	85	-	64	2,400	5	1 57665 58 A					
	<ul style="list-style-type: none"> VERSION WITH CONSTRUCTION KEY Dead-bolt only 	 3 item 1 00163 00 1  1 item 1 00120 00 1 (construction key)	5	3,5	28	4	85	-	64	2,550	1	1 B7655 28 A					
			4	3,5	38	4	85	-	64	2,550	1	1 B7655 38 A					
			5	3,5	28	4	85	-	64	2,300	5	1 B7655 48 A					
			4	3,5	38	4	85	-	64	2,300	5	1 B7655 58 A					
	<ul style="list-style-type: none"> VERSION WITH CONSTRUCTION KEY Latch-bolt and dead-bolt 	 3 item 1 00163 00 1  1 item 1 00120 00 1 (construction key)	4	3,5	28	4	85	-	64	2,700	1	1 B7665 28 A					
			3	3,5	38	4	85	-	64	2,700	1	1 B7665 38 A					
			4	3,5	28	4	85	-	64	2,400	5	1 B7665 48 A					
			3	3,5	38	4	85	-	64	2,400	5	1 B7665 58 A					

Type	Description	Item key	Dead-bolts							Unit weight	Pieces	ITEM					
			No.	Projection	Distance	Throws	Distance	Faceplate	Backset			Type	Dim.	Hard	Fin.	Pers.	Spec.
	<ul style="list-style-type: none"> Latch-bolt and dead-bolt Electrically controlled dead-locking latch-bolt Voltage: 12 V ac CE Slide item 1.06224.50.00 	 3 item 1 00162 00 1	4	-	28	4	85	35	67	2,900	1	1 17635 28 A					
			4	-	28	4	85	35	67	2,750	5	1 17635 48 A					
	<ul style="list-style-type: none"> VERSION WITH CONSTRUCTION KEY Latch-bolt and dead-bolt Electrically controlled dead-locking latch-bolt Voltage: 12 V ac CE Slide item 1.06224.50.0 	 3 item 1 00162 00 1	4	-	28	4	85	35	67	3,000	1	1 17685 28 A					
			4	-	28	4	85	35	67	2,850	5	1 17685 48 A					
		 1 item 1 00120 00 1 (construction key)															
	<ul style="list-style-type: none"> Dead-bolt only 	 3 item 1 00162 00 1	5	-	28	4	85	35	67	2,700	1	1 57625 28 A					
			5	-	28	4	85	35	67	2,400	5	1 57625 48 A					
	<ul style="list-style-type: none"> VERSION WITH CONSTRUCTION KEY Dead-bolt only 	 3 item 1 00162 00 1	5	-	28	4	85	35	67	2,800	1	1 57675 28 A					
			5	-	28	4	85	35	67	2,500	5	1 57675 48 A					
		 1 item 1 00120 00 1 (construction key)															
	<ul style="list-style-type: none"> Latch-bolt and dead-bolt 	 3 item 1 00162 00 1	4	-	28	4	85	35	67	2,850	1	1 57635 28 A					
			4	-	28	4	85	35	67	2,550	5	1 57635 48 A					
	<ul style="list-style-type: none"> VERSION WITH CONSTRUCTION KEY Latch-bolt and dead-bolt 	 3 item 1 00162 00 1	4	-	28	4	85	35	67	2,950	1	1 57685 28 A					
			4	-	28	4	85	35	67	2,650	5	1 57685 48 A					
		 1 item 1 00120 00 1 (construction key)															
	<ul style="list-style-type: none"> VERSION WITH CONSTRUCTION KEY Dead-bolt only 	 3 item 1 00162 00 1	5	-	28	4	85	35	67	2,800	1	1 B7675 28 A					
			4	-	38	-	85	35	67	2,800	1	1 B7675 38 0					
	 1 item 1 00120 00 1 (construction key)	 3 item 1 00162 00 1	5	-	28	4	85	35	67	2,500	5	1 B7675 48 A					
			4	-	38	-	85	35	67	2,500	5	1 B7675 58 0					
		 1 item 1 00120 00 1 (construction key)															
	<ul style="list-style-type: none"> VERSION WITH CONSTRUCTION KEY Latch-bolt and dead-bolt 	 3 item 1 00162 00 1	4	-	28	4	85	35	67	2,950	1	1 B7685 28 A					
			3	-	38	-	85	35	67	2,800	1	1 B7685 38 0					
	 1 item 1 00120 00 1 (construction key)	 3 item 1 00162 00 1	4	-	28	4	85	35	67	2,650	5	1 B7685 48 A					
			3	-	38	-	85	35	67	2,200	5	1 B7685 58 0					
		 1 item 1 00120 00 1 (construction key)															



Ingersoll Rand's Security Technologies Sector is a leading global provider of products and services that make environments safe, secure and productive. The sector's market-leading products include electronic and biometric access-control systems; time-and-attendance and personnel scheduling systems; mechanical locks; portable security; door closers, exit devices, architectural hardware, and steel doors and frames; and other technologies and services for global security markets.

www.ingersollrand.com

CISA SpA
Via Oberdan, 42
48018 Faenza (RA) Italy
Tel. +39 0546 677111
Fax +39 0546 677150
www.cisa.com